

## Piani cottura da incasso semifilo - profondità 46 cm

Built-in hobs with flat edge - depth 46 cm

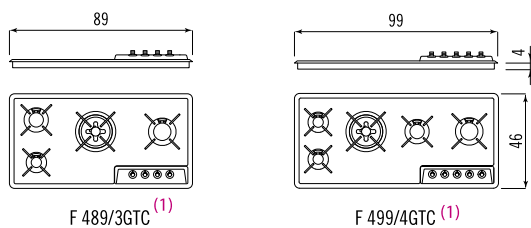

F 489/3GTC (1)

F 499/4GTC (1)

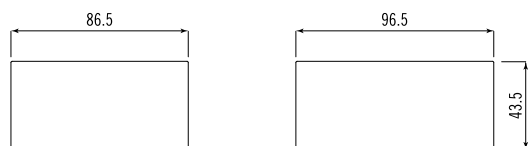

## Piani cottura da incasso - profondità 56 cm

Built-in hobs - depth 56 cm

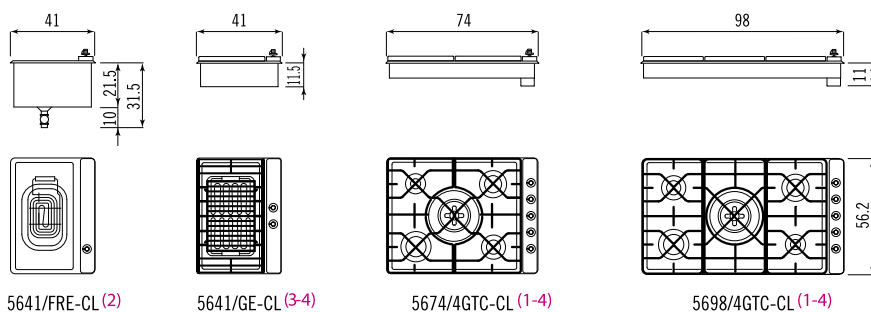

5641/FRE-CL (2)

5641/GE-CL (3-4)

5674/4GTC-CL (1-4)

5698/4GTC-CL (1-4)

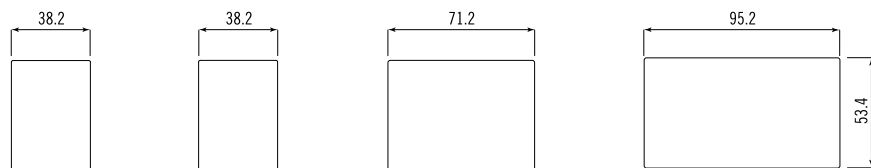

(1) Con bruciatore tripla corona Dual, 4.5 kw; Equipped with Dual triple crown burner, 4.5 kw.

(2) La friggitrice è completa di coperchio e 2 cestini; The deep-fryer is supplied with lid and two wire baskets.

(3) Nel grill la roccia lavica è in dotazione; Lava rock in on equipment for the grill.

(4) Con griglia in ghisa; With cast iron grid.

Piani cottura da incasso semifilo - profondità 51 cm  
 Built-in hobs with flat edge - depth 51 cm

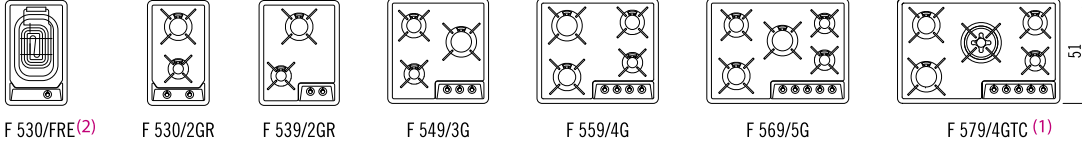
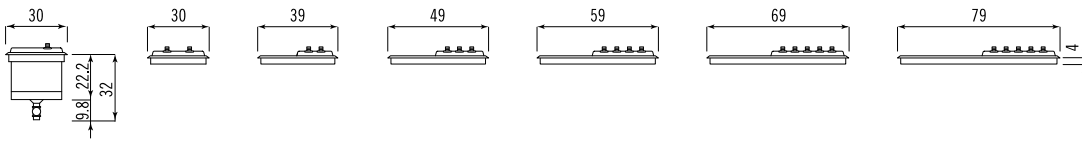

F 530/FRE (2)    F 530/2GR    F 539/2GR    F 549/3G    F 559/4G    F 569/5G    F 579/4GTC (1)



F 530/GE (3)    F 530/2GG    F 539/2GG    F 579/6G



F 530/BPE    F 530/TC (1)    F 539/TC (1)    F 579/4EI (5)

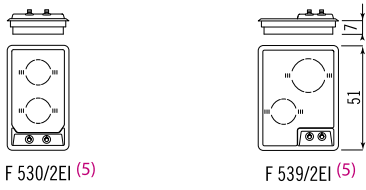

F 530/2EI (5)    F 539/2EI (5)

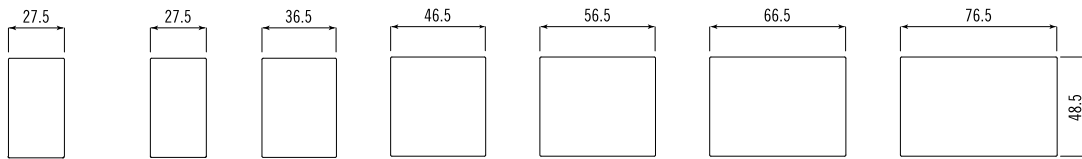

(5) Cottura a induzione; Induction cooking.